

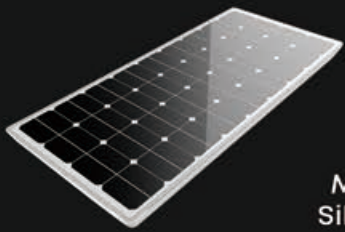


ISE ALL IN ONE
SOLAR STREET LIGHT


OVER 10 YEARS 
EXPERIENCE
www.aokledlight.com

> Features of SE Series


- SE solar LED street light features all in one design function, low profile design, with PIR/microwave motion sensor and smart controller all built in.
- Bilateral Solar Panel design. Suitable for remote region, non electricity supply zone.
- Deep cycle battery, charge and discharge over 2000 times.
- Operating time: Operate 5~7 rainy days under intelligent model.
- Power range: from 10W to 60W.



Integral Monocrystalline Silicon Solar Panel



Conversion Rate up to 30%

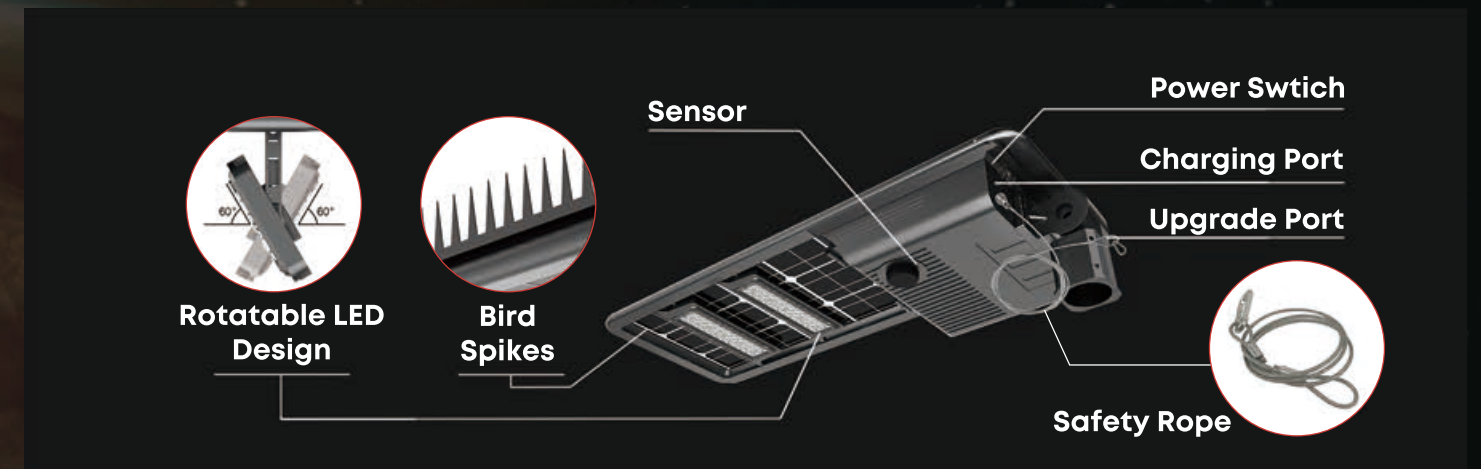










25 Years Lifespan



>2000 times
Lifespan Cycle
High quality Li-ion battery
Intelligent temperature control

UP TO 200 lm/W	CRI 70/80/90	3000K 4000K 5000K 5700K 6500K	L90B10 >52000hrs @ 25°C	IP65
BIFACIAL SOLAR PANEL	ROTATABLE LED MODULE	DIM	ZIGBEE/4G/LORA	Smart Sensor



-  Ultra-high light efficiency. 10 watts equivalent to 20 watts of others at least.
-  Bifacial solar panels. The overall conversion efficiency is increased by 30%.
-  Unique anti-theft technology on battery door. Easy battery replacement design.
-  Rotatable LED module. Worry-free installation, best solar panel angle adapt to the sun.
-  Various installation methods. Suit for any application likes light poles, wall surface and etc.
-  Replace the traditional 35-400 watts. From 10 to 60 watts, meeting all road application conditions.
-  More than 30 different road optical designs. Adapt to various road conditions but no waste of light.
-  PIR/microwave motion sensor and smart controller all built in. AC and DC complementary.

3 5 **WARRANTY**
3 Year Limited Warranty,
5 Year Preferred Warranty.
Please consult with our sales for detailed agreement.

wally@aokledlight.com
+1 626-986-4050 (US)
+86 755 2357 9148 (CN)
©2022 AOK LED LIGHT CO., LTD. All Right Reserved.



> Photometrics Design

Lumen efficiency >200lm/W achieve higher illumination

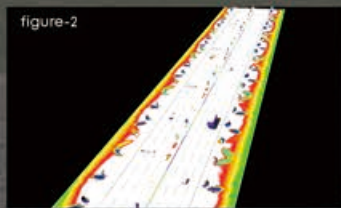
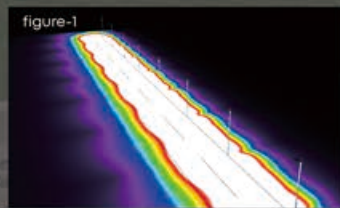


Seoul 5050 LED chip creates a first-class light source. By choosing it, single lumen efficacy >200lm/W, with the aluminum lamp base and sealed lens, with its excellent heat dissipation, it is as if the LED chip has been placed in a sealed unit. Thus it maintains high brightness levels with very little fading. The sealed lenses are made of strong UV-protected PC and are aging and shock-resistant; The well-optimized light distribution makes for a more uniform and wider lighting area.

Distribution

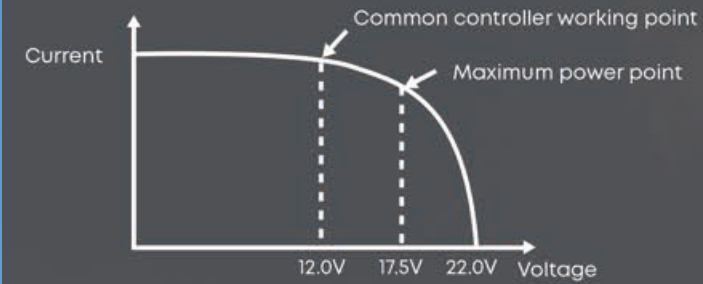


Figure-1: Example of rural branch road
Figure-2: Example of mian road or avenue



Planning and analysis of street lights can be done by using lighting simulation & design software, which allows the lighting effect a more intuitive display. It uses rendering, the process of generating an image from a model, by means of computer programs resulting in different tools for measuring the simulated light levels.

Advantages of controller

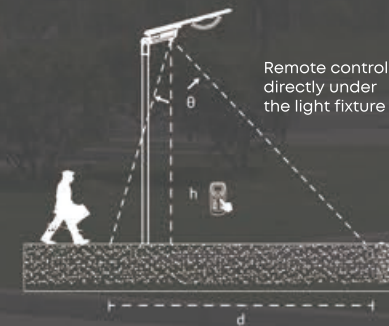


(take 12V battery system as an example)

- 1) Moving Track MPPT maximum power tracking technology is adopted to improve the tracking efficiency and speed by more than 20%;
- 2) UltraGreen power control technology with extremely low static power consumption and sleep current;
- 3) 10 time-periods programmable load power/time control;
- 4) Multiple intelligent power modes can be selected, and the load power can be automatically adjusted according to the battery power;
- 5) Multiple protection functions such as battery /PV reverse connection protection, LED short circuit/open circuit/power limit protection;
- 6) Aluminum metal housing, IP67 waterproof rating, can be used in a variety of harsh environments
- 7) Extensible IoT remote communication monitoring function;

Detection distance

Remote control distance 5-8 meters, installation height and environment and other factors will affect the controller sensitivity, please refer to the actual field.
Note: Please do not place 2 or more lights within 12 meters at the same time while using the remote controller, receiving or sending may fail.



Inductive Type	θ (Angle)	h (Height of lamp rod)	d (Inductive width)
IR (Infrared)	60°	6-8m	6-10m
WB (Microwave)	65°	6-10m	7-10m

*Remote control is optional

> Bifacial Solar Panel

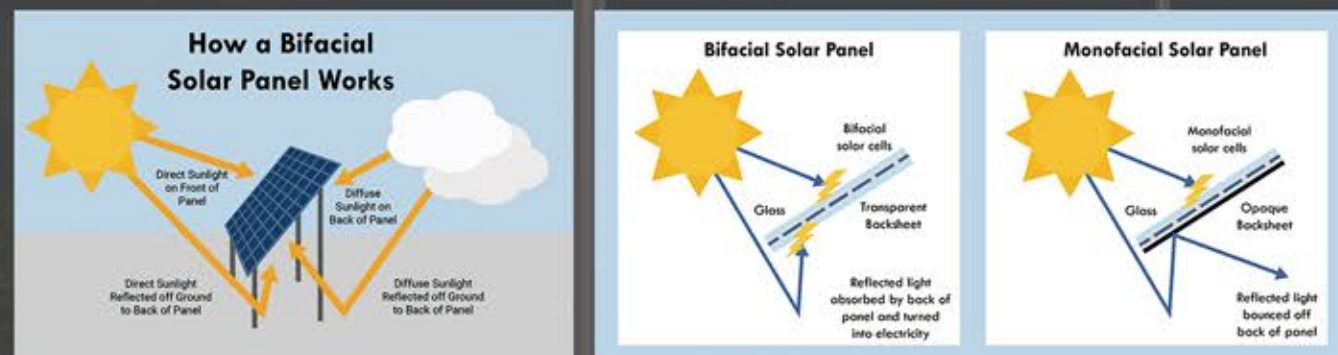


Cost-effectiveness

Cost is one of the biggest factors a big factor – particularly in the case of monofacial modules. The cost of bifacial modules has fallen precipitously over the last two decades. Notably, as costs have decreased, so too has the cost gap between mono- and bifacial modules.

High Conversion Efficiency

There is no doubt bifacial modules will increase power production. Results and studies have shown that bifacial modules can produce additional power between 10–20% over monofacial panels. If conditions are optimized and single-axis trackers adopted, the additional power can be as high as 30–40%.



Other Benefits

• Site Selection:

The site selection of the bifacial panels can be optimized. For places where land is less expensive, monofacial panels should be laid in the right direction to ensure maximum energy collection. However, bifacial modules can have optimal spacing and therefore higher yields. Also, bifacial yields are greater where the diffuse light energy is greater, which means at higher latitudes the bifacial yield will be greater than at lower latitudes.

• High Albedo:

The environment has a high albedo that is great for bifacial panels compared with monofacial panels. Desert sand is even a better option. The best option is white concrete or highly reflective roof foil. Snow and ice also have a very high albedo.

• Tilt:

More flexible than monofacial panel. Bifacial panels can receive light even at sunset. This will vary from site to site, but generally, 2~15 degrees more than the monofacial tilt has been shown to be effective.

> Application Reference

- Road lighting
- Area lighting
- Perimeter lighting

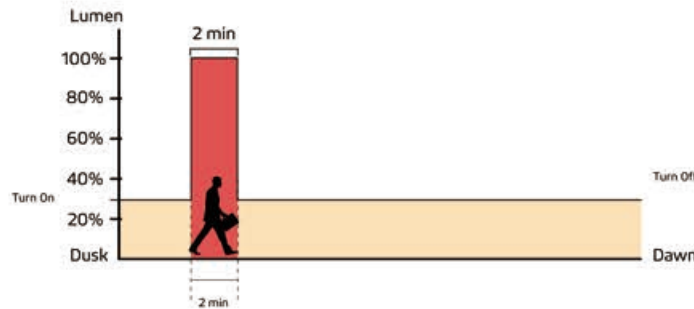


> Smart City Starts with Smart Lighting

AUTONOMY CONTROL REFERENCE

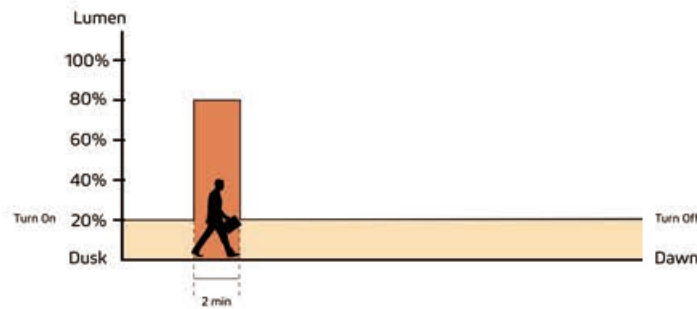
30%~100% MOTION SENSOR MODE

Constant 30% brightness (turns on at dusk, turns off at dawn);
100% brightness turns on for 2 minutes when motion is



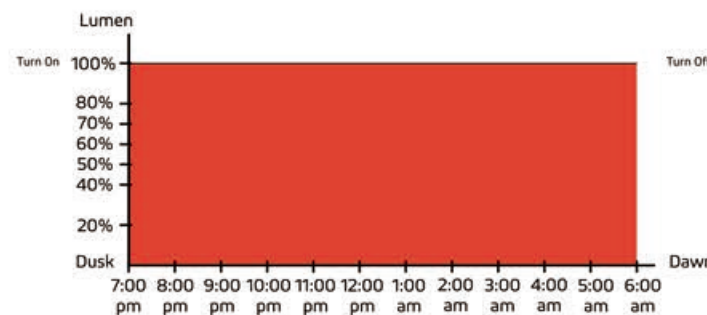
20%~80% MOTION SENSOR MODE

Constant 20% brightness (turns on at dusk, turns off at dawn);
80% brightness turns on for 2 minutes when motion is



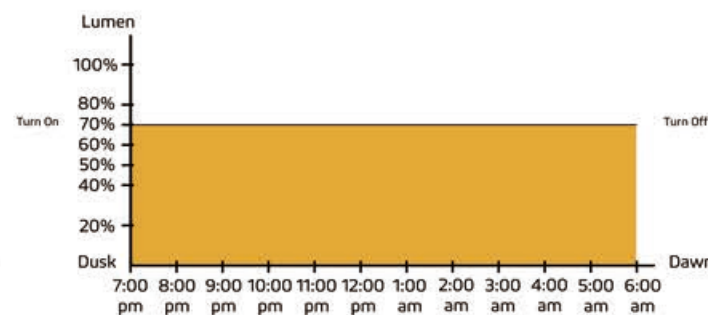
100% CONSTANT MODE

100% brightness from dusk to dawn.



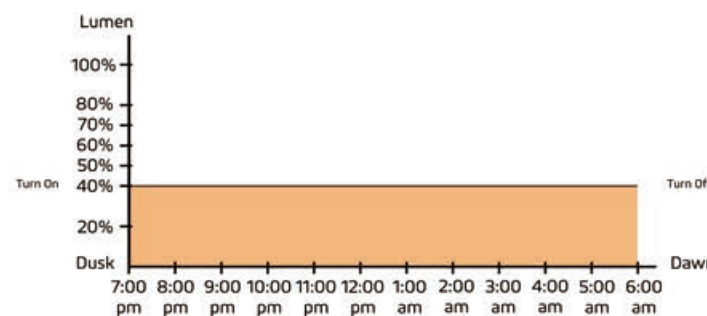
70% CONSTANT MODE

70% brightness from dusk to dawn.



40% CONSTANT MODE

40% brightness from dusk to dawn.



PROGRAMABLE CONTROLLER OPTIONAL

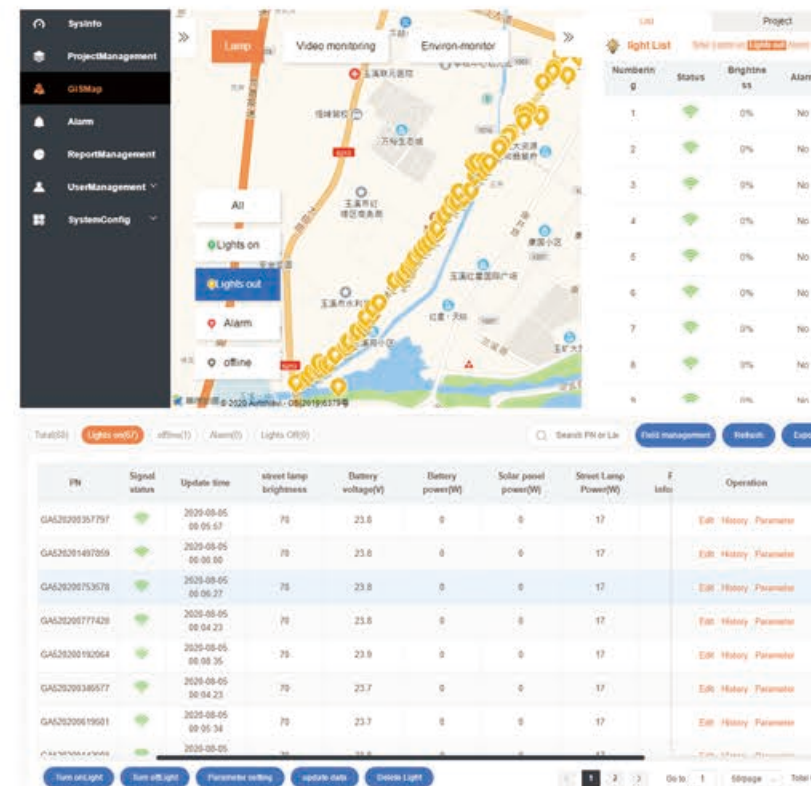


A programmable remote control is used to adjust the appropriate plan according to the different periods of daylight and road conditions in each area and season.

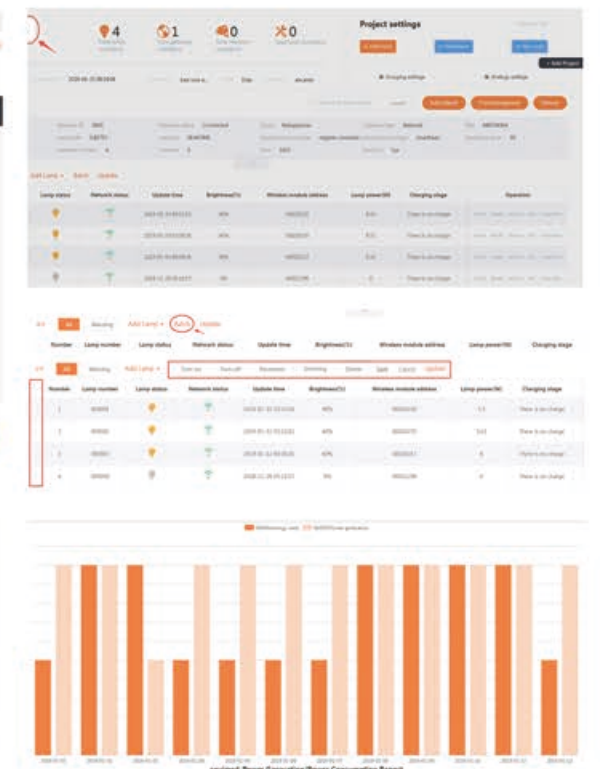
Default mode

- 1) 4H-Detected 100%, None 30%;
- 2) 3H-Detected 70%, None 30%;
- 3) 3H-Detected 50%, None 20%;
- 4) 4H-Detected 30%, None 10%;
- 5) Subject to specific order

SMART LIGHTING CONTROL SYSTEM



DATA & PROJECT MANAGEMENT



The Internet of Things solar street light management system can pre-set one or more lighting modes according to the different time of day and traffic flow, automatically turn on or off any light, and adjust the switching time and illumination according to environmental requirements to achieve the purpose of energy-saving and consumption reduction.

The integrated system is mainly composed of a street light component a centralized controller, a single light controller, and a smart cloud platform. The centralized controller and the single light controller aggregate the data collected by the single light via the GPRS/NB-IoT wireless communication network. The centralized controller uploads data to the system cloud platform through GPRS data flow, providing data dependence for mobile phone and computer terminal access.

APP CONTROL



Remote monitoring real time monitoring

With wireless communication function, through the intelligent management system of solar street light and wireless module, have remote monitoring and real-time monitoring.



Automatic fault alarm

Real-time monitoring of solar panel voltage, current, power, battery charging and discharging current, voltage, load working state, controller working state data, and fault automatic alarm.



Remote control

Support remote switch on/off dimmer and battery, load parameter modification.



Fault tracking and precise positioning

Multi peak PWM technology, suitable for partial shading or damage of photovoltaic cells, and the tracking efficiency is more than 99%.



Map location

Using GPS maps, with geographic display capabilities.



*Note :APP is only available in 4G scheme

> Application of Typical Networking of Smart Street Light(optional)

Strategy Control

By installing the node of the street light controller on the ambient light sensor, electric energy metering unit to collect to the street light power (voltage, current, power), and the ambient light conditions, according to the administrator deployment strategy to mobilize installed on the street light controller of the automatic control system to control the street light switch, adjust brightness, color temperature adjustment, etc.;

Gateway Control

The Lora Light wireless system with strong anti-interference ability is adopted in the wireless transmission unit of the street light controller to realize the communication between nodes and gateways. The data of various sensors on the node street lamp controller is sent back to the gateway, and the control command of the gateway is also sent to the node street light controller.

Cloud Platform

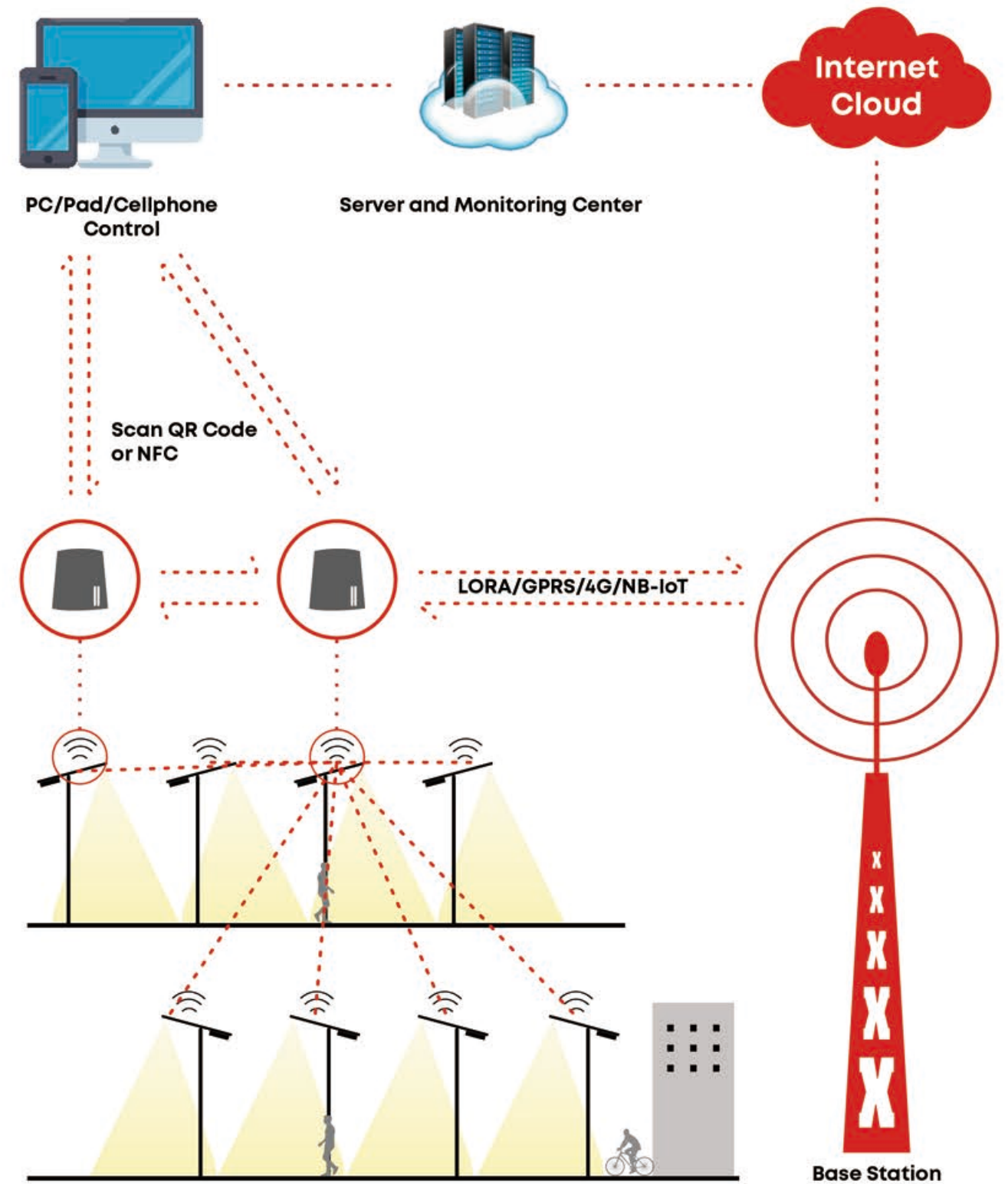
The gateway controller transmits the street light control information of all nodes under the gateway to the cloud platform through GPRS/3G/4G/NB-IOT (optional) wireless mode, and at the same time sends the instructions of the cloud platform to the street light controller of each node.

Controller ZigBee/4G/LoRa



- Built-in IoT controller module;
- Adopt Moving Track MPPT maximum power tracking technology, with higher tracking efficiency and faster speed;
- Lead-acid battery and lithium battery are universal. Operating parameters can be set by remote controller;
- Ultra green power control technology with extremely low static power consumption and dormant current;
- Lead acid battery multi-stage temperature compensated constant voltage charging;
- 10 Programmable load power/time control setting;
- Battery charging and discharging high and low temperature protection function, working temperature can be set;
- A variety of intelligent modes can be selected, automatically adjust the load power according to the battery power;
- High precision digital booster constant-current control algorithm, high efficiency and high constant-current precision;
- 2.4G wireless communication, can set read parameters, read status, etc;
- Battery/PV reverse connection protection, LED short circuit/open circuit/limited power protection and other multiple protection functions.

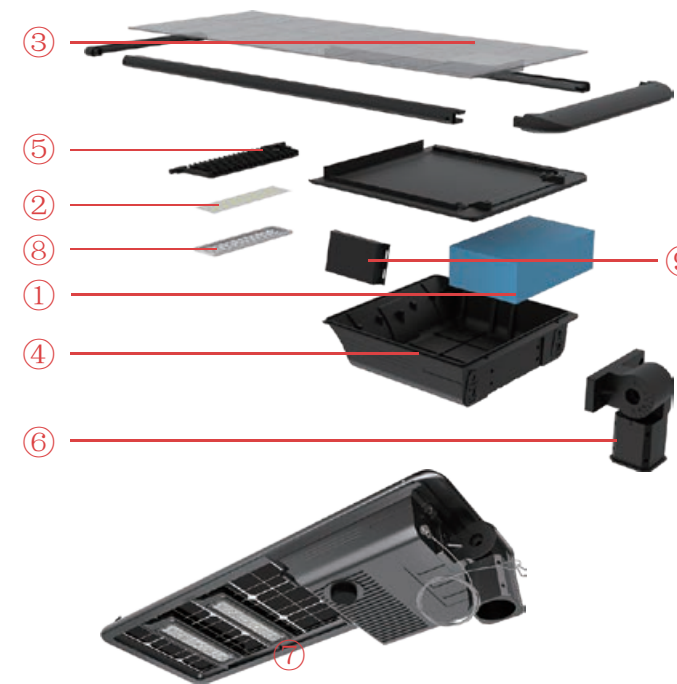
APPLICATION OF TYPICAL IOT NETWORKING



Parameter Table

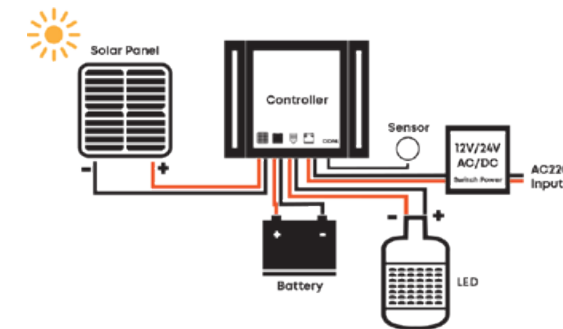
Electrical Data							
Model	AOK-10Ws E	AOK-20Ws E	AOK-30Ws E	AOK-40Ws E	AOK-50Ws E	AOK-60Ws E	
Power(W)	10W/15W	20W/25W	30W/35W	40W/45W	50W	60W	
Control Option	Photocell sensor, timing, dimming, intelligent power saving, microwave sensor. LoRa, 4G, Zigbee, Smart Lighting Control optional.						
Photometric Data							
LED Manufacturer	Seoul						
LED model	Seoul 5050						
Lens	Polycarbonate						
Efficacy (lm/W, Std. Dev. ±3%)@CCT=5700K, CRI>70Ra	200lm/W	190lm/W	196lm/W	192lm/W	192lm/W	190lm/W	
Luminous flux (lm, Std. Dev. ±3%)@CCT=5700K, CRI>70Ra	2000lm	3800lm	5880lm	7680lm	9600lm	11400lm	
ULOR	= 0%, @ Luminaire inclination 0°						
CCT	3000K, 4000K, 5000K, 5700K, 6500K						
CRI	70Ra, 80Ra, 90Ra optional						
Beam angle	T2(60°*156°)/T3(75°*160°)/T4(78°*153°)						
Mechanical Data							
IP Rating	IP65, according to standard EN 60529						
SCx	Front: 0.3465 m²; Front-side: 0.0535 m²; Side: 0.0622 m²;	Front: 0.3465 m²; Front-side: 0.0535 m²; Side: 0.0622 m²;	Front: 0.4143 m²; Front-side: 0.0535 m²; Side: 0.0669 m²;	Front: 0.4831 m²; Front-side: 0.0535 m²; Side: 0.0706 m²;	Front: 0.5537 m²; Front-side: 0.0535 m²; Side: 0.0743 m²;	Front: 0.6215 m²; Front-side: 0.0535 m²; Side: 0.0790 m²;	
Housing	Heavy-duty die-cast aluminum (EN AC-46100)						
Surface treatment	Anti-UV thermosetting polyester / 80 micron epoxy primer + Anti-UV thermosetting polyester (for extremely corrosive environments).						
Painting	Black, Custom request						
Mounting	Universal/Wall mount/Round pole/Square pole						
Solar Panel Data							
Photovoltaic panel	Double crystal photovoltaic panel						
Solar Panel	18V/30W	18V/40W	18V/50W	18V/60W	18V/70W	18V/80W	
Li-ion Battery	153.6WH	230.4WH	307.2WH	384.0WH	460.8WH	537.6WH	
	12.8V12AH	12.8V18AH	12.8V24AH	12.8V30AH	12.8V36AH	12.8V42AH	
Charging Time	5.12Hrs	5.76Hrs	6.14Hrs	6.40Hrs	6.58Hrs	6.72Hrs	
Battery lifespan	>2000 times cycle						
Run Time(@full power)	15hrs / 10hrs	11.5hrs / 9hrs	10hrs / 8.5hrs	9.5hrs / 8.5hrs	9hrs	9hrs	
Ambient Temperature	-10°C to 50°C (14°F to 122°F)						
Storage Temperature	-20°C to 45°C (-4°F to 113°F)						
Charging Temperature	-0°C to 45°C (32°F to 113°F)						
Control system	PWM/ IoT, Complementary solution, MPPT optional						
Maximum Autonomy	Operate 5~7 rainy days under intelligent model.						
Others							
Lifespan	L90B10 > 52000h, @Ta 25°C						
Warranty	3 years (Warranty extension up to 5 years on request)						
Certification	UL/ CUL FCC SAA RCM CE RoHS, the company is ISO 9001 and ISO 14001 certified, For other certificates please request						
Product Size	633*365.5*211.4mm	793*365.5*211.4mm	948*365.5*211.4mm	1103*365.5*211.4mm	1263*365.5*211.4mm	1418*365.5*211.4mm	
Net Weight	11.49kg	12.86kg	14.89kg	16.5kg	17.61kg	19.66kg	
Carton Size	860*210*440mm	1020*210*440mm	1175*210*440mm	1330*210*440mm	1490*210*440mm	1645*210*440mm	
Gross Weight	14.5kg	15.86kg	17.97kg	19.6kg	21.49kg	22.44kg	
Recommend installation height	3-6m	5-7m	5-8m	6-9m	6-10m	7-12m	
Application field	Urban and rural street						

Construction Features



- 1- Easy battery replacement design, can be renewed for 7 years.
- 2- Ultra-high light efficiency, 10 watts equivalent to 20 watts of others at least.
- 3- Bilateral solar panels, the overall conversion efficiency is increased by 30%.
- 4- Unique anti-theft technology on battery door.
- 5- Rotatable LED module, worry-free installation, best solar panel angle adapt to the sun.
- 6- The various installation methods suit for any application likes light poles, wall surface and etc.
- 7- From 10 to 60 watts, can replace the traditional 35-240 watts, meeting all road application conditions.
- 8- Customizable optical road lighting designs, adapt to various road conditions but no waste of light.

Working Way



The solar panel receives solar radiation energy and converts it into electricity, which is stored in the battery by the photovoltaic controller. At night, when the illumination gradually decreases to about 10LUX and the solar panel voltage is 5V, the charge and discharge controller detects this voltage value, and controls the battery to discharge for the LEDs to complete the process of daytime charging and evening discharge.

Ordering Information

AOK	WATTS	VOLTAGE	LED CHIPS	TYPE OF SENSOR	CCT&CRI	DISTRIBUTION	MOUNT	COLOR
10WSE	NV=12.8V DC	S5=Seoul 5050	00=Without Sensor	3070=3000K 70CRI	120=120DEG	Type A	BK=Black	
15WSE			SN=Motion Sensor	4070=4000K 70CRI	T2=TYPE II	Type B		
20WSE			(up to 9M)	5070=5000K 70CRI	T3=TYPE III	Type C		
25WSE			PIR=PIR Sensor (up to 7M)	5770=5700K 70CRI	T4=TYPE IV	Type D		
30WSE			DV=Dimmable	6570=6500K 70CRI				
35WSE				3080=3000K 80CRI				
40WSE				4080=4000K 80CRI				
45WSE				5080=5000K 80CRI				
50WSE				5780=5700K 80CRI				
60WSE				6580=6500K 80CRI				

Accessories (Order separately)
 Intelligent APP control
 IOT Management
 AC & DC complementary

SE Series Specification Sheet

*Due to the constant improvements in product development, individual parameters might change. Please refer to our sales or R&D team for most up-to-date content as specifications are subject to change without notice.

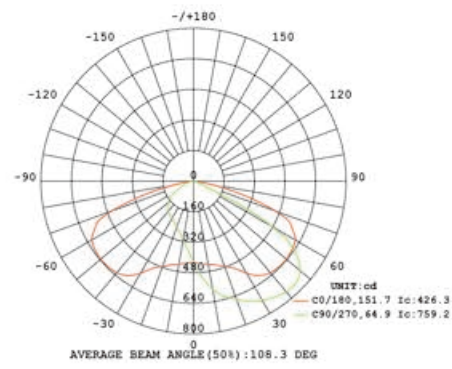
wally@aokledlight.com
 +1 626-986-4050 (US)
 +86 755 2357 9148 (CN)

©2022 AOK LED LIGHT CO., LTD. All Right Reserved.

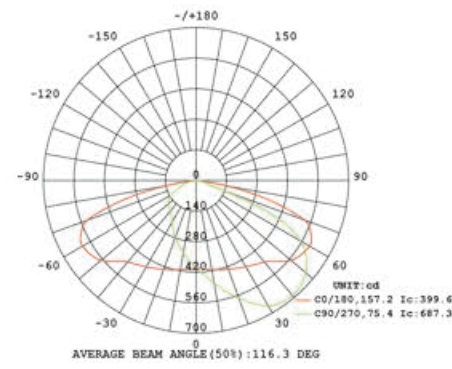


Photometry

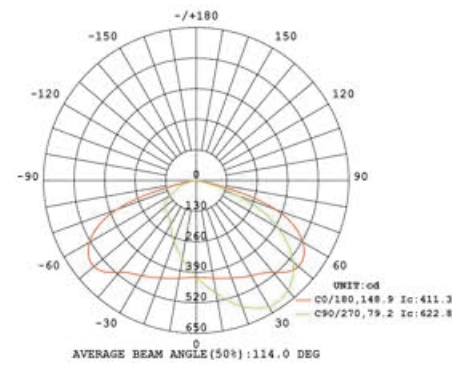
Type II



Type III

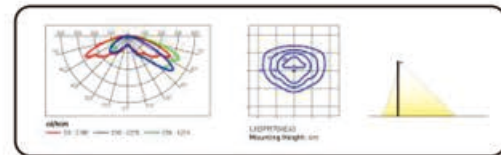
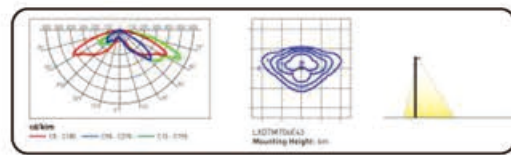


Type IV

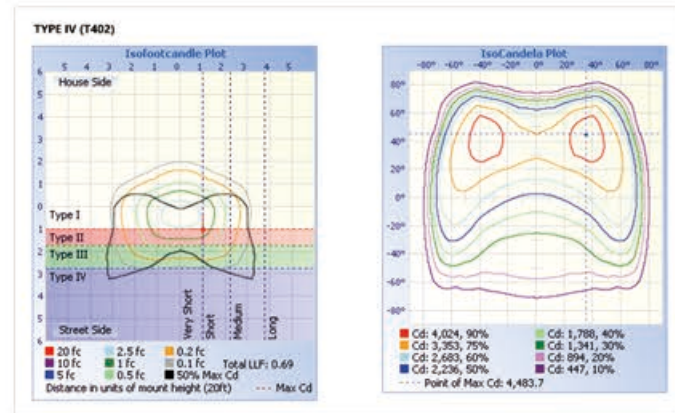
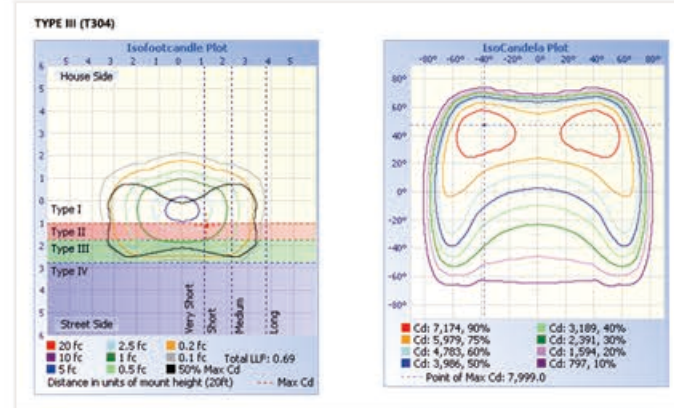
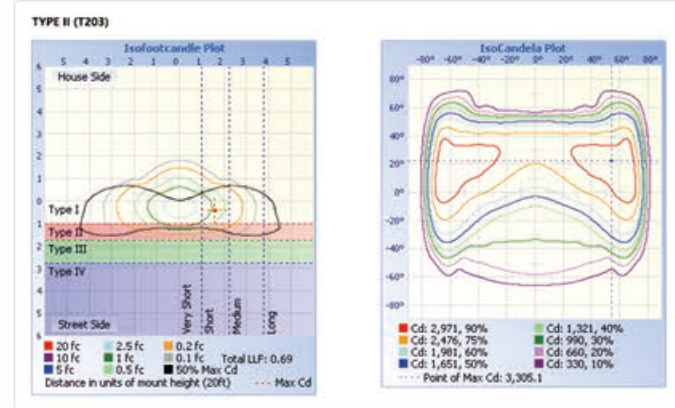


Type 2 for street lighting, cycle paths and footpaths

Type 3 for street light and car parks

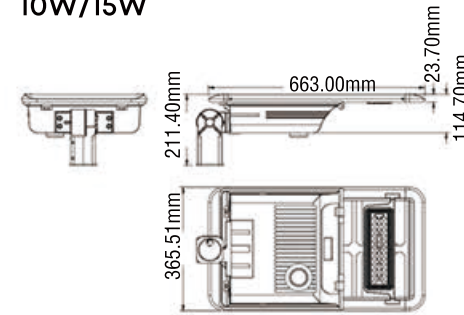


Illuminance Diagram

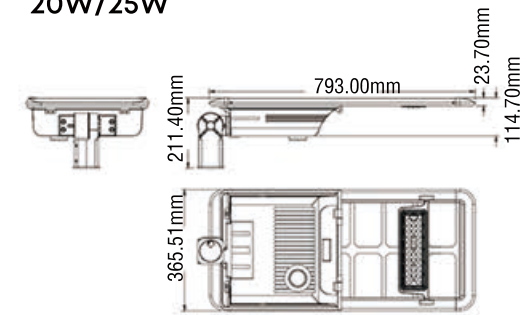


Dimensions

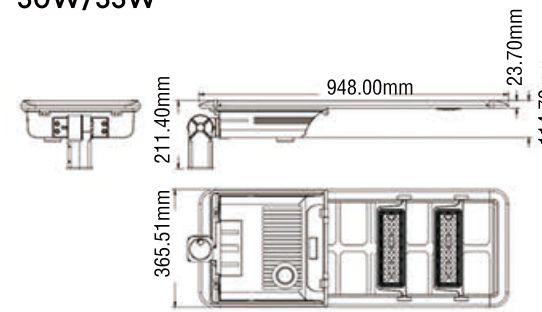
10W/15W



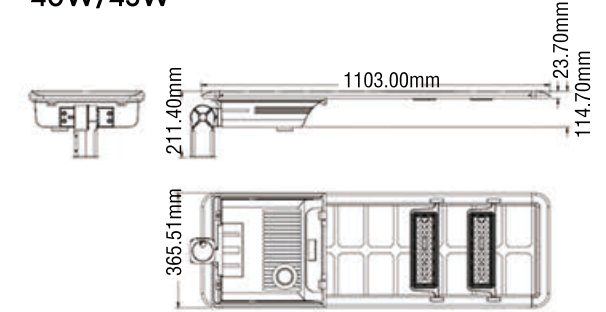
20W/25W



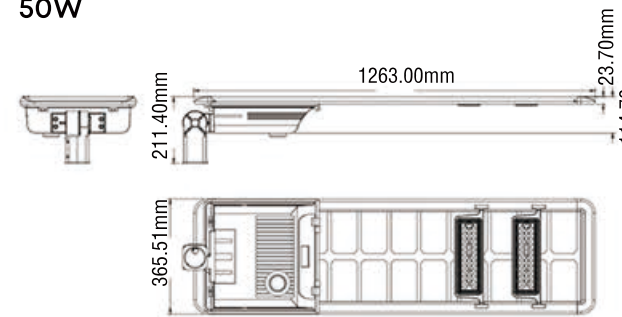
30W/35W



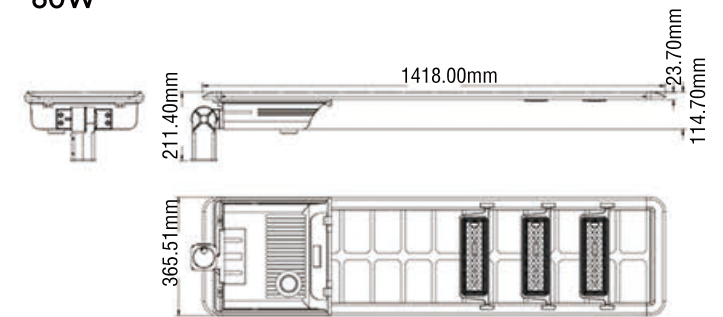
40W/45W



50W

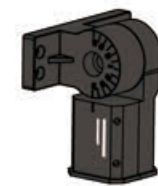


60W

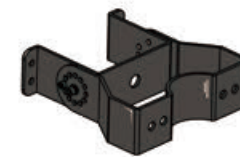


Accessories

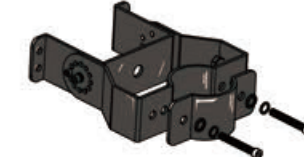
Mounting Options



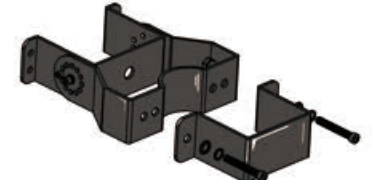
Type A
Universal Bracket



Type B
Wall Mount



Type C
Round Pole



Type D
Square Pole



Bird Spikes



PIR/microwave
Motion Sensor



Programmable
Remote Control



MPPT
ZigBee/4G/LoRa



Safety rope

*As the products are upgraded, the accessories may differ from those described in the pictures. Please consult with our sales team for updated details and order separately.

SE Series Specification Sheet

*Due to the constant improvements in product development, individual parameters might change. Please refer to our sales or R&D team for most up-to-date content as specifications are subject to change without notice.

wally@oakledlight.com
+1 626-986-4050 (US)
+86 755 2357 9148 (CN)

©2022 AOK LED LIGHT CO., LTD. All Right Reserved.





Illuminate Your Future



wally@aokledlight.com
www.aokledlight.com
+1 626-986-4050 (US)
+86 755 2357 9148 (CN)

Manufacturing: Building 1 & 4, St. George's Science and Technology Industrial Park, Shajing Street, Shenzhen, China, 518124.
Fuzhou HQ: Room 301, Yujing Business Center Zone 1, No. 12 Baihuazhou road, Cangshan district, Fuzhou, China, 350007
NorthAmerica HQ: 18541 E Gale Ave, City of Industry, CA91748 USA

Copyright ©2022 AOK LED LIGHT CO., LTD. All Right Reserved.